

BEACON OPTRONICS

The Shape of light

PRODUCT DATA-SHEET

CUSTOM SERIES

52x1 60Deg

BO65-Custom-52x1-2835/3030-60°



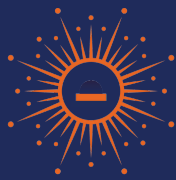

BEACON OPTRONICS
The Shape of light

60°

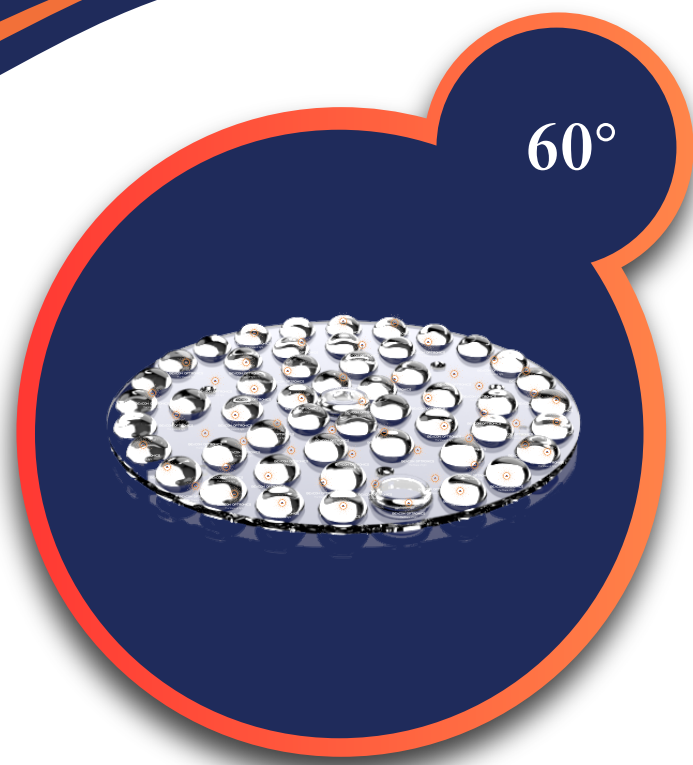

Applications



Industrial



Stadium Light



Flood Light



Highbay Light

Table of Contents

▶ Features & Application	1
▶ Material & Optical Specifications	2
▶ Mechanical Specifications & Instructions.....	3
▶ Term & Conditions	4

Features & Applications

- Optimized for 2835/3030 led (Osram, Lumileds, Seoul) Higher efficiency and Luminous flux.
- Outstanding Optical design to achieve a perfect distribution and overall uniformity.
- Complying UI94 specification and UV protected.
- The installation is flexible & the number of lenses can be flexibly selected according to the power/module of the lamp.
- Complete light distribution to meet North American road standards, European standards and GB-CJJ45-2015 (Me4)

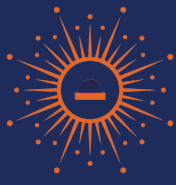

BEACON OPTRONICS
The Shape of light

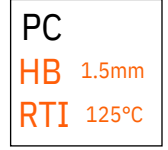
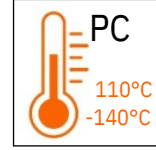
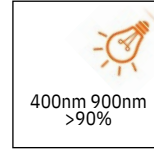

Material Specifications

- ▶ **Lens Material:** Polycarbonate(Makrolon 2407&2647/Teijin1225Z)
- ▶ **Operating Temperature:**PC: -40°C~+110°C (Upper Limit +120°C)
- ▶ **UL Flammability:**PC 2407/1225Z: V-2 @0.75mm & HB @2.7mm
- ▶ **UL RTI Elec:** PC 2407/1225Z: 125°C @1.5mm
- ▶ **Light Transmission Rate 400nm~900nm > 90%**
- ▶ **Refractive Index-:** 1.584 (ISO 489/ASTM D542)

Optical Specifications

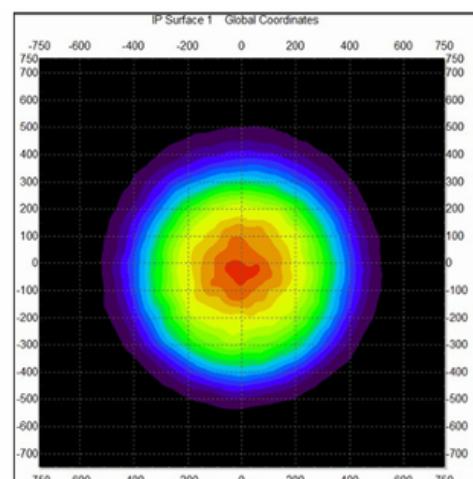
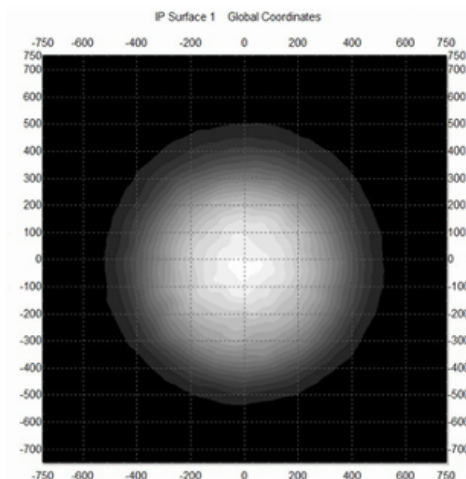
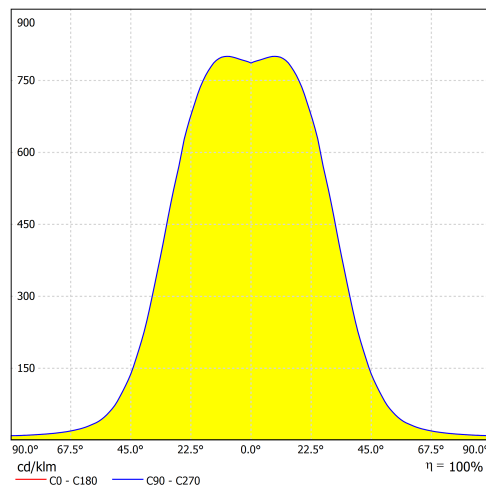
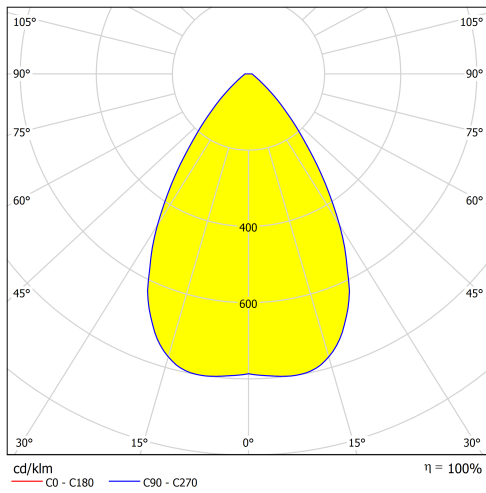

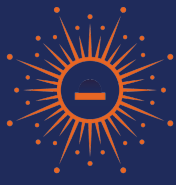

BEACON OPTRONICS
The Shape of light

Mechanical Specifications

Fastening:- Glue



Screw



Tape



Frame

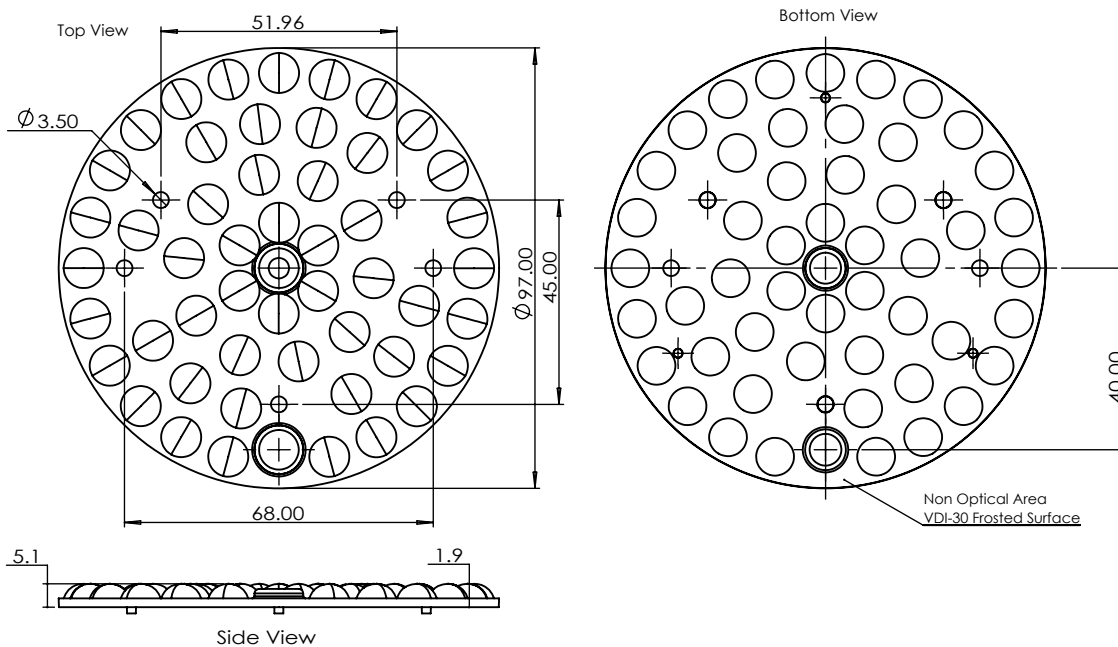

General Information

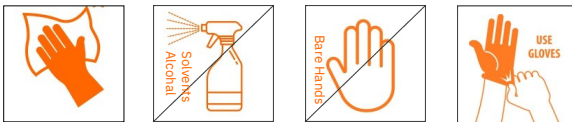

- ▶ If necessary, clean lenses with mild soap, water and soft cloth.
- ▶ Never use any commercial cleaning solvents on lenses, like alcohol.
- ▶ Please handle or install lenses with wearing gloves, skin oils may damage lens or its optical characteristic.

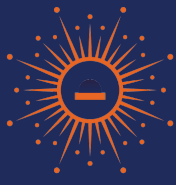

BEACON OPTRONICS
The Shape of light

Terms & Conditions



- **Disclaimer of Warranty:** The information provided in this datasheet is provided "as is" without any warranty, express or implied, including but not limited to the warranties of merchantability, fitness for a particular purpose, and non-infringement. The company makes no representations or warranties regarding the accuracy, completeness, or reliability of the information contained herein.
- **Limitation of Liability:** In no event shall the company be liable for any direct, indirect, special, incidental, consequential, or punitive damages arising out of or in connection with the use or performance of the information provided in this datasheet, even if the company has been advised of the possibility of such damages.
- **Use at Your Own Risk:** The information provided in this datasheet is for informational purposes only and is not intended to constitute advice or recommendations. Users of this datasheet are responsible for ensuring the suitability and safety of the product for their intended use and assume all risks associated with the use of the information provided herein.
- **Intellectual Property Rights:** All intellectual property rights in the information provided in this datasheet, including but not limited to copyrights, trademarks, and patents, are owned by the Beacon Optronics. No license or right is granted to use any of these intellectual property rights except as expressly provided in this datasheet
- **Changes and Updates:** The company reserves the right to make changes to the information provided in this datasheet at any time without notice. It is the responsibility of users to regularly check for updates and changes.